

# LED 2028

## SENSOR-CONTROLLED TOE KICK LIGHT



Water Tolerant



12 V SYSTEM

IP44

- > \*CRI 90 lights are Title 24 Compliant
- > \*CRI 90 lights offer more vibrant, true color rendering than lower CRI products
- > Cannot be dimmed
- > Delay time: approx. 4 min.
- > Motion sensor range: 120° and 2000 mm (78 3/4")



- > Driver see page 51
- > Drill bit see page 146

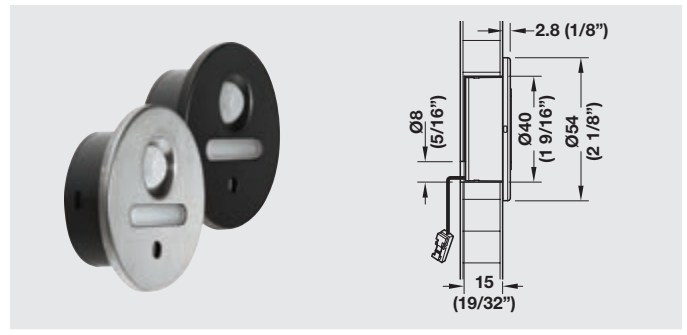

| Item No.                                  | 833.73.110  | 833.73.111     |
|---|---|----------------|
| <b>SRP</b>                                | <b>\$27.00</b>  | <b>\$27.00</b> |
| Light Color (K)                           | 2700 (warm white)   |                |
| Drill hole                                | Ø40 mm (1 9/16")  |                |
| Ø x H                                     | 54 x 17.3 mm (2 1/8" x 11/16")  |                |
| Wattage                                   | 0.34  |                |
| LEDs                                      | 3   |                |
| Lumen                                     | 4   |                |
| Lumen per watt                            | 12  |                |
| CRI                                       | 90*   |                |
| Energy Efficiency class                   | A+  |                |
| Weighted energy consumption (kWh/1.000 h) | 0.37  |                |
| Material                                  | Stainless Steel   |                |
| Finish                                    | brushed steel   | matt black     |
| Supplied with                             | 2 m (78 3/4") lead, mounting material, silicone gasket                      |                |
| <b>Note</b>                               | Loox Lights and Drivers are "Suitable for use within Closet Storage Spaces" |                |

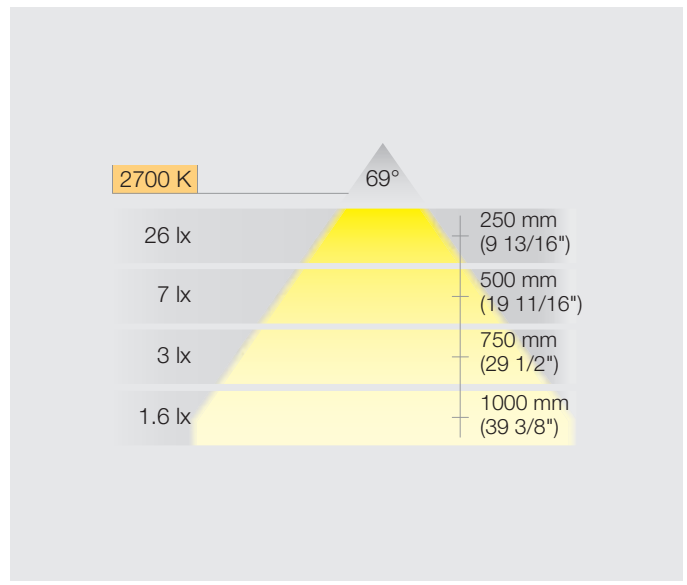

# LOOX LED DRIVER

CONSTANT VOLTAGE 12 V

12 V SYSTEM

THIN PROFILE

- 1 Item No. 833.74.960  
 $\otimes_1 + \otimes_2 + \dots + \otimes_6 < 20 \text{ W}$
- 2 Item No. 833.74.962  
 $\otimes_1 + \otimes_2 + \dots + \otimes_6 < 40 \text{ W}$
- 3 Item No. 833.74.964  
 $\otimes_1 + \otimes_2 + \dots + \otimes_6 < 60 \text{ W}$   
**max. 42 W per light output**

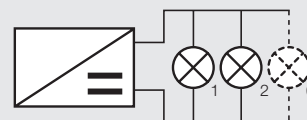

Parallel connection

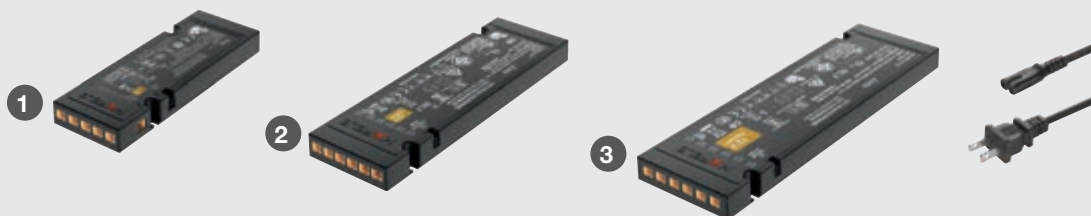

- > Suitable for all of the world's power systems
- > With an integrated port for a wide selection of switches
- > Max. 42 W per light output
- > Lead length from driver to switch: Max.: 6 m (236 1/4")

- ! > Class 2
- > Efficiency Level VI
- > Degree of protection : IP20
- > Loos drivers cannot be controlled by a dimmer wall switch

| Item No.                          | 833.74.960 1  | 833.74.962 2                              | 833.74.964 3                               |
|-----------------------------------|---|---|--|
| SRP                               | \$36.00   | \$60.00                                   | \$80.00                                    |
| L x W                             | 140 x 50 x 16<br>(5 1/2" x 2" x 5/8")                                       | 190 x 60 x 16<br>(7 1/2" x 2 3/8" x 5/8") | 230 x 70 x 16<br>(9 1/16" x 2 3/4" x 5/8") |
| Wattage                           | 0 – 20  | 0 – 40                                    | 0 – 60                                     |
| Standby Power Consumption Wattage | <0.1  | <0.1                                      | <0.2                                       |
| Input voltage                     | 100 – 240 V~; 50 – 60 Hz  |   |  |
| Output voltage                    | 12 V DC   |   |  |
| Output current                    | 1.67 A  | 3.33 A                                    | 5.0 A                                      |
| Number of slots                   | 6 for lights, 1 for switch, 1 for power cord                                |   |  |
| Material/Finish                   | Plastic, black  |   |  |
| Supplied with                     | Mounting accessories, US power cord   |   |  |
| <b>Note</b>                       | Loos Lights and Drivers are "Suitable for use within Closet Storage Spaces" |   |  |

- ➔ > Switches see pages 113 - 116
- > Extension leads see page 127

- + Power cord with 90° plug  
2 m (78 3/4")
- > Item No. 833.89.017 **SRP \$5.00**

- 90° Plug adapter
- > Item No. 833.89.018 **SRP \$7.00**

| Country-specific 2 m (78 3/4") primary leads |            |            |            |            |            |            |            | 3 m (118") |
|--|------------|------------|------------|------------|------------|------------|------------|------------|
| Item No.                                     | 833.89.000 | 833.89.001 | 833.89.002 | 833.89.003 | 833.89.016 | 833.89.005 | 833.89.050 | 833.89.008 |
| SRP  | \$10.00    | \$4.00     | \$4.00     | \$4.00     | \$4.00     | \$4.00     | \$4.00     | \$6.00     |
| Plug design                                  |            |            |            |            |            |            |            |            |
| Designation                                  | UK         | AU         | EU         | US         | JP         | CN         | US         | US         |
| Voltage (V)                                  | 250        | 250        | 250        | 120        | 100        | 250        | 120        | 120        |

# LED DRIVER

## CONSTANT VOLTAGE PLUG-IN DRIVER

### 12 V SYSTEM

-  > Degree of protection: IP20
- > 4 m (157 1/2") lead
- > Class 2



| Item No.                   | 833.74.934                                   | 833.74.936                                    | 833.74.938                               |
|----------------------------|--|---|--|
| <b>SRP</b>                 | <b>\$12.00</b>                               | <b>\$20.00</b>                                | <b>\$30.00</b>                           |
| L x W x H                  | 61 x 37 x 43<br>(2 3/8" x 1 1/2" x 1 11/16") | 78 x 46 x 54<br>(3 1/16" x 1 13/16" x 2 1/8") | 84 x 50 x 58<br>(3 5/16" x 2" x 2 5/16") |
| Stand-by Power Consumption | 0.3 W  |   |  |
| Input voltage              | 100-240 V; 50-60 Hz                          |   |  |
| Output voltage             | 12 VDC                                       |   |  |
| Output current             | 6  | 15  | 27                                       |
| Degree of protection       | IP 20  |   |  |
| Number of slots            | 1 socket for lead                            |   |  |
| Material/Finish            | Plastic, black                               |   |  |

**Note**  
Loox Lights and Drivers are "Suitable for use within Closet Storage Spaces"

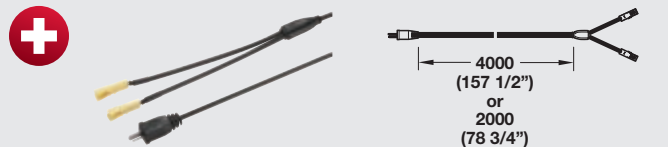

Secondary lead 12 V, Plastic, black with 2 connections

- > 4 m (157 1/2") Item No. 833.74.749 **SRP \$8.00**
- > 2 m (78 3/4") Item No. 833.74.791 **SRP \$8.00**

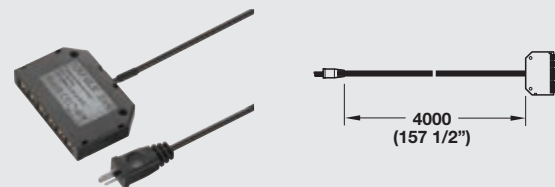

Secondary lead 12 V, Plastic, black with 6-way distributor, 4 m (157 1/2")

- > Item No. 833.74.748 **SRP \$12.00**

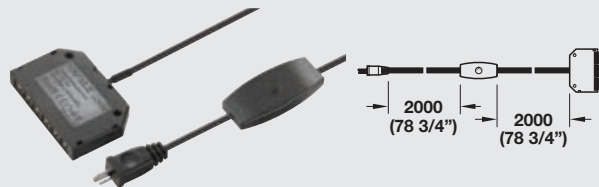

Secondary lead 12 V, Plastic, black with dimmer and 6-way distributor

- > Item No. 833.74.709 **SRP \$30.00**

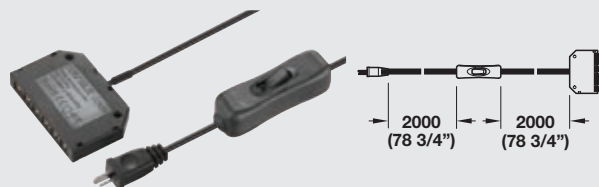

Secondary lead 12 V, Plastic, black with rocker switch and 6-way distributor

- > Item No. 833.74.746 **SRP \$24.00**